

END TABLE

ASSEMBLY INSTRUCTIONS



ASSEMBLY INSTRUCTION

ASSEMBLY TIPS:

- 1.Remove hardware from box and sort by size.
- 2.Please check to see that all hardware and parts are present prior to start of assembly.
- 3.Please follow attached instructions in the same sequence as numbered to assure fast & easy assembly.



Warning!!

- 1.Don't attempt to repair or modify parts that are broken or defective. Please contact the store immediately.
- 2.This product is for home use only and not intended for commercial establishment.

ASSEMBLY TIME PER UNIT: 35 MINUTES

PARTS IDENTIFICATION

A The mirror part provided in this package is not a tempered mirror. Please handle with care. Mirror part may explode.

MIRROR BOX

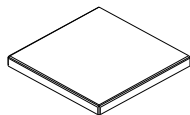

1PC

B

SIDE FRAME

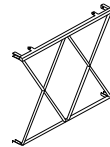

2PCS

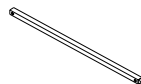

C

CROSSBAR



4PCS

HARDWARE PACKAGE

Z	DESCRIPTION	FIGURE	Q'TY
1	SHORT BOLT (1/4"x15mm)		12PCS
2	LEVELER (1/4"x12mm)		4PCS
3	ALLEN WRENCH (4mm)		1PC

STEP 1

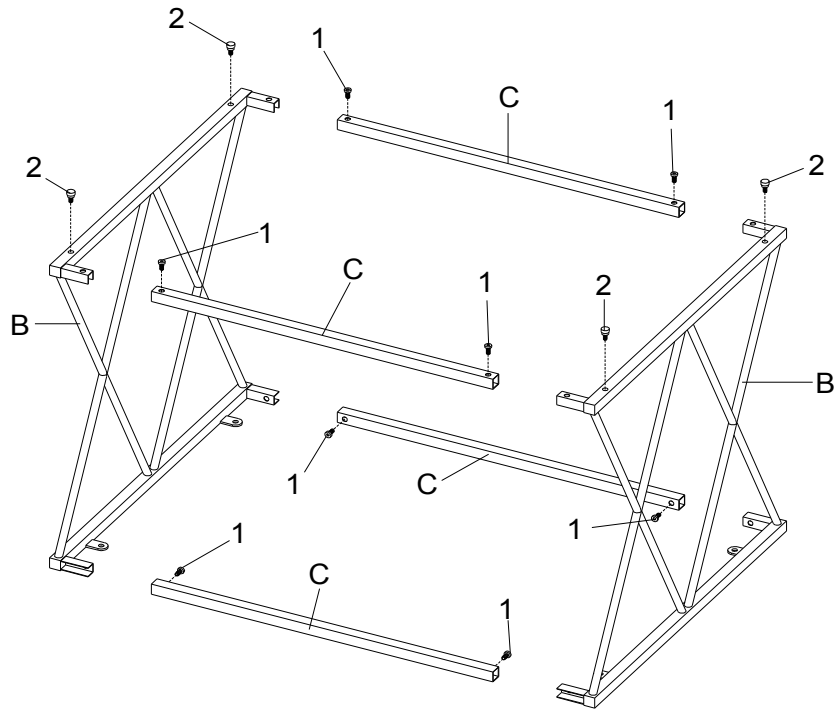

STEP 2

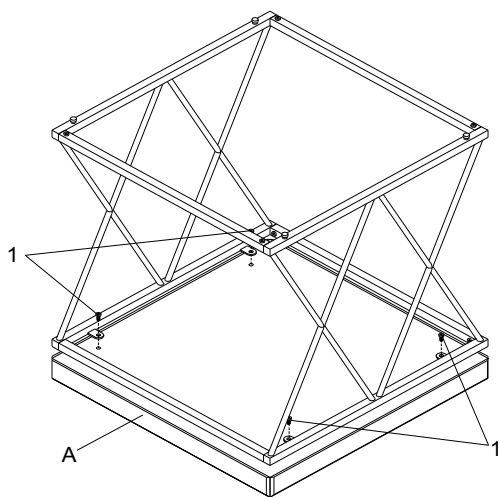

FINISH

