

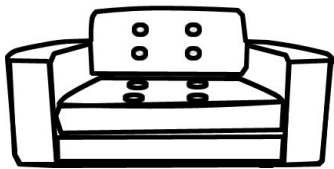











**ITEM NAME/NOM D'ITEM : PUGET ARM CHAIR**

**ITEM #/NO.ITEM : 100217/100218/100219**

**PARTS LIST / LISTE DES PIÈCES**

(1)	(2)	(3)												
 <p style="text-align: right;">X4</p>	 <p style="text-align: center;">X1</p>	<table border="0"> <tr> <td>A.</td> <td></td> <td>X1</td> </tr> <tr> <td>B.</td> <td></td> <td>X8</td> </tr> <tr> <td>C.</td> <td></td> <td>X8</td> </tr> <tr> <td>D.</td> <td></td> <td>X8</td> </tr> </table>	A.		X1	B.		X8	C.		X8	D.		X8
A.		X1												
B.		X8												
C.		X8												
D.		X8												

**ASSEMBLY INSTRUCTIONS/INSTRUCTIONS D'ASSEMBLAGE**

**I**

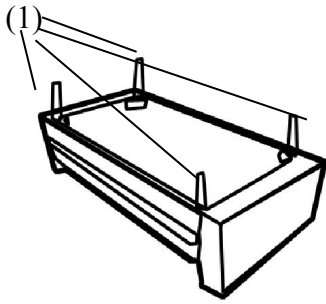

(2)

**II**

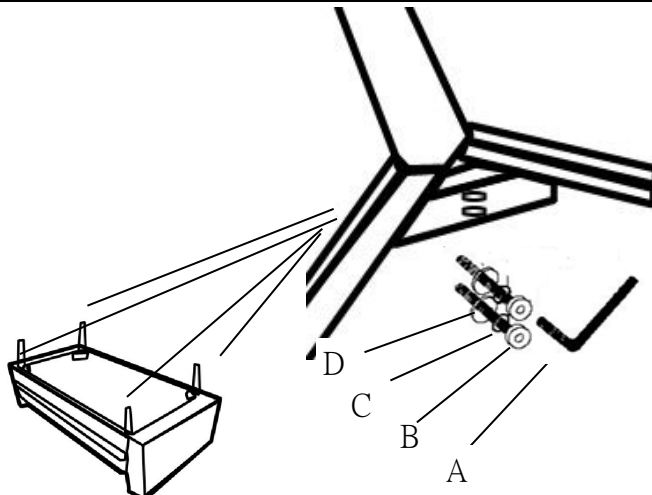

**III**

